

MADJAX

Part # 02-107 Alpha **LUX** Kit 02-130 Alpha Ultimate Plus **LED Light Kit**

(will fit Alpha Body/Club Car® Precedent & Tempo)



ITEMS INCLUDED

- Headlights
- Tail Lights
- Light Mounting Brackets
- Alpha Bucket Harness
- Turn Signal Assembly
- Column Cover
- Hardware Pack
- 48-12V Converter
- Horn
- Brake Switch
- USB Charger
- **LUX** Module (02-107 only)

TOOLS NEEDED

- #2 Phillips Tip
- 1-1/8" Paddle Bit
- Torx Bit Socket Set
- 1/2" Wrench
- 13mm Socket
- Rotary Cutting Tool

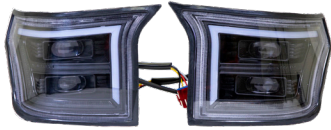

Headlights



Taillights



Brake Switch



Turn Signal Assembly
w/Control Box



Column Cover



Horn

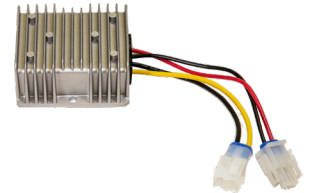

Converter

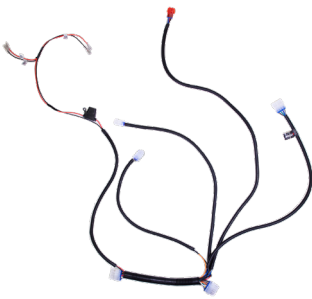

Alpha Front
Harness

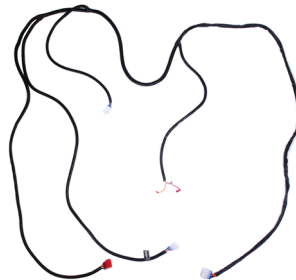

Alpha Bucket
Harness



Light Mounting
Brackets



USB Port



LUX Module
for 02-107

LUX Control Box Module

LUX Module
controlled by
Happy Light App



iOS 7.0 & Android 4.3

WARNING:

Madjax recommends professional installation. If you choose to not have this product installed by a professional, we highly recommend that you exercise caution, care, and patience when installing this product as it involves drilling holes into your cart's body.

***ATTENTION: The Instructions for the Ultimate Plus & LED LUX Light Kits are identical and should be installed in conjunction with the Alpha Body kit instructions to avoid repeating steps.**

STEP 1

Switch key to OFF position. Place TOW/RUN switch to TOW. It is not required to remove the batteries but you do need to disconnect the main negative.



STEP 2

Remove all screws securing floor mat to the vehicle using a T40 Torx Bit. Remove floor mat & retain hardware.

Remove the brake adjustment access panel for Brake switch installation later.

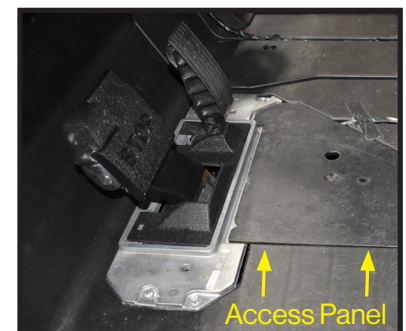

STEP 3

Temporarily remove factory body screws using a T27 Torx Bit.

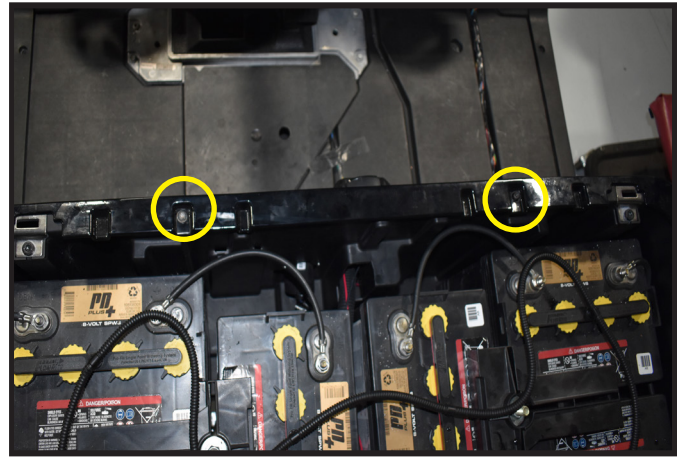

STEP 4

Using a small screwdriver, pry charge receptacle cover from vehicle.

Remove the screws securing the lower body trim to the body using a T40 Torx Bit. Remove the lower body trim and retain hardware.

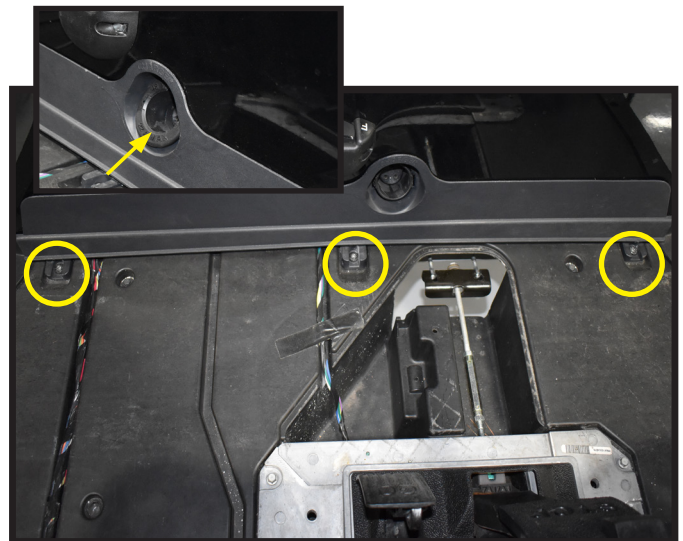

STEP 5 *BUCKET HARNESS INSTALL*

Starting from the battery compartment, feed the front of the **Alpha Bucket Harness** to the front using the access hole under the FNR switch as shown. Continue pulling the harness until the brake connections (red & orange wires) are even with the brake pedal. Place the Bucket Harness in the open floor channel to avoid humps in the floor mat.

Route the Brake Light connectors through the center floor channel that leads to the brake access panel.

Leave the tail light and power connections in the battery well until later.

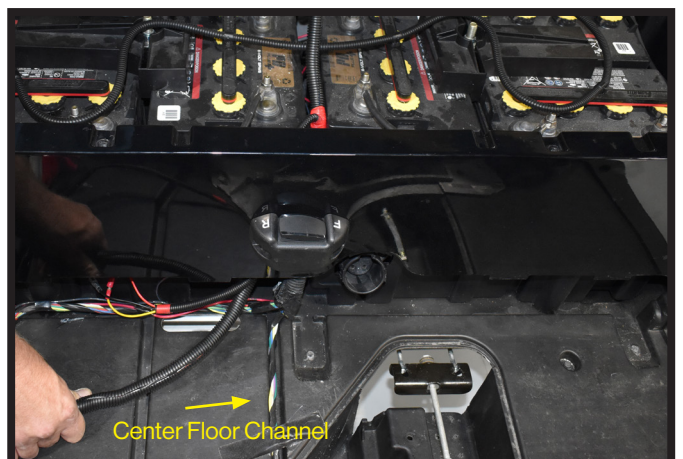

NOTE: See Page 14 for the Harness Layout, if needed.

STEP 6

Remove and retain the instrument panel screws to access dash area using T25 & T10 Torx Bits.



STEP 7

Route the two headlight connectors and horn wires through the opening behind instrument panel to the front. (For LUX kits there will be an additional 2 pin connector to route through the opening as well).

NOTE: There is a Front Harness legend at the end of the instructions for a better orientation of the wire layout.



STEP 8

Plug 12 Pin connector of the turn signal module to the light kit harness.



STEP 9 *USB CHARGER INSTALL*

Using a 1-1/8" Paddle Bit, find a desired location on your golf cart dashboard to mount your USB charger. Ensure your location is free of obstacles and will not affect dash reattachment.

NOTE: If you do not have access to a 1-1/8" Paddle Bit you can use the inside of the USB ring nut as a template.

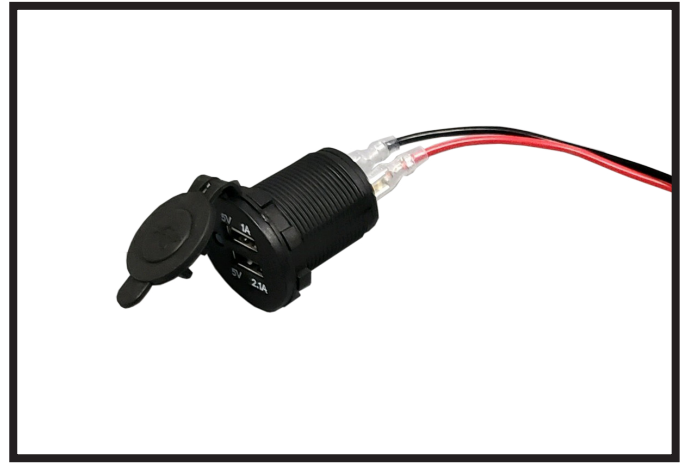

STEP 10

Using the USB ring nut, secure the charger to your cart.

Attach the red & black connectors from the light kit harness to the spade terminals on the back of the charger, red to (+) and black to (-).

NOTE: Secondary connectors can be used to supply power to another 12 volt accessory with less than 7.5 amp draw.

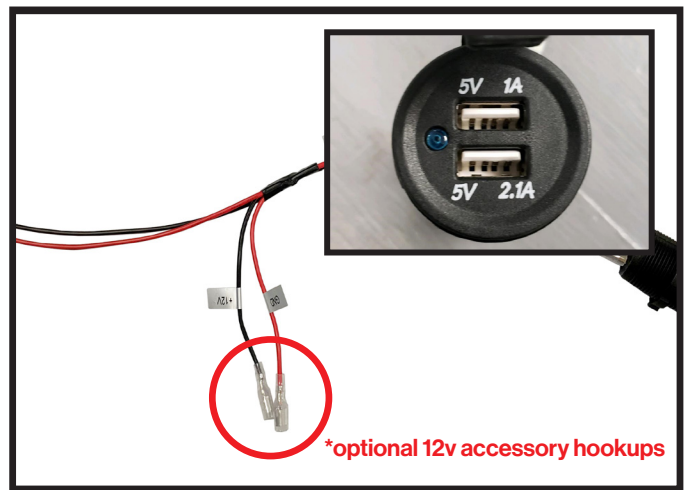

STEP 11 *TURN ASSEMBLY INSTALL*

Mount Turn Signal Indicator assembly using clamps provided and tighten clamps evenly. Run Turn Signal Indicator harness along steering column and insert harness through dash.



STEP 12

Attach back cover to turn signal assembly.

Attach column cover to steering column, secure harness in column cover void.

NOTE: The hazard switch is pre-installed to the Turn Signal housing. No additional steps are required to install hazard switch.



STEP 13

Attach horn to purple and black female spade connectors from front of harness and secure horn to metal framework under front cowl with a self tapping screw.

NOTE: Wires have no orientation and will work on either post.

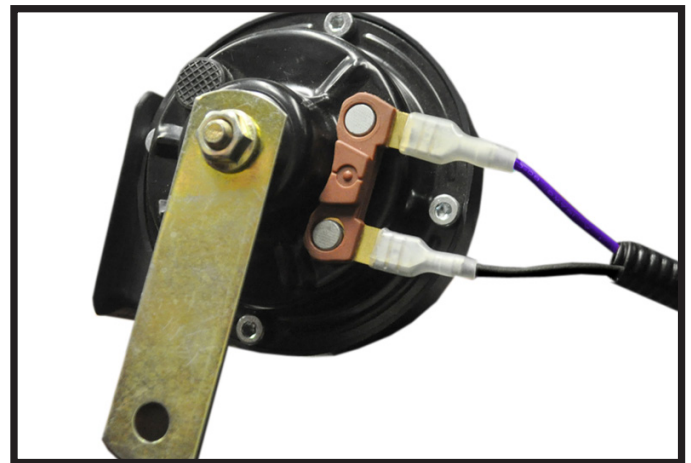

STEP 14 *AUXILIARY SWITCH FEATURE*

The turn signal handle has a secondary, 2-position rotary switch for auxiliary 12 volt lighting such as fog lights and/or LED light bars. There is one common negative wire and two positive wire connections to run two different auxiliary lights.

Additional wiring and lighting not included. Reinstall dashboard using retained hardware from Step 6.

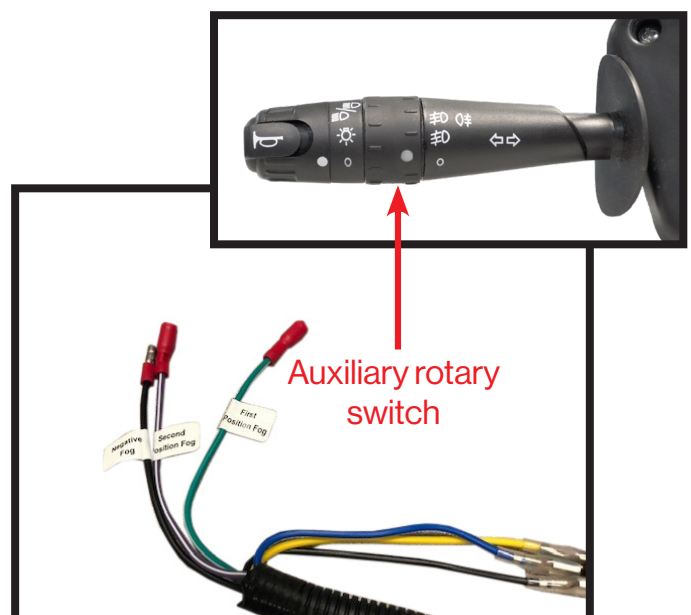

STEP 15

BRAKE SWITCH INSTALL

NOTE: Disengage Brake before and during brake switch installation.

A) Loosen jam nut on brake rod using a 1/2" wrench. Place the forked bracket around the brake rod behind the Jam nut and tighten the Jam nut sandwiching the bracket. Place the brake switch on the floor of the car with the spring running towards the back of the car to the brake switch.

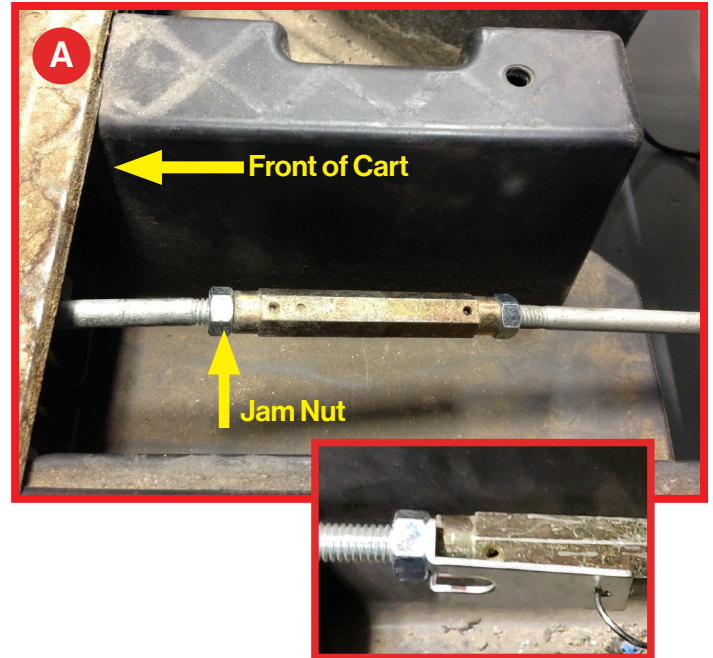

B) Adjust the brake switch so that the spring has no slack but the switch is not engaged. Screw the brake switch to the floor of the car with self tapping screws.



C) Plug the 2 bullet connectors from the brake switch into the corresponding bullet connectors on the light kit harness. Secure all wiring so that it is away from moving parts.

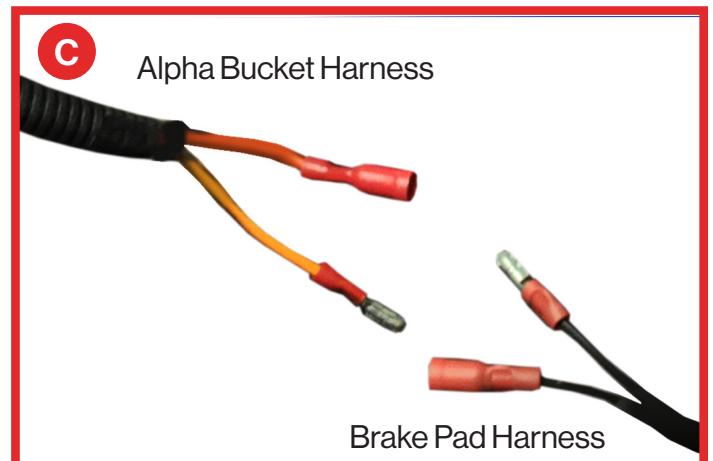

STEP 16

To mount the front headlights, the 8 small brackets pictured will be used. There are three different sized brackets that all have specific locations where they need to be mounted.

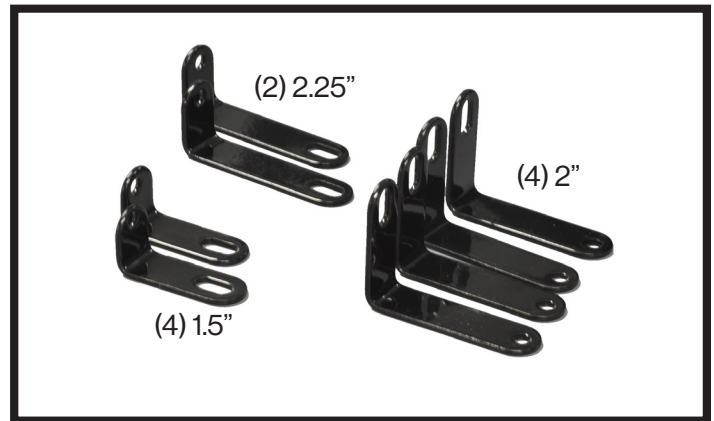

STEP 17

Attach two of the 2" headlight brackets to the bottom tabs of the cowl using the large head half inch screw as shown. Be sure that the slotted holes are facing towards the headlight opening.

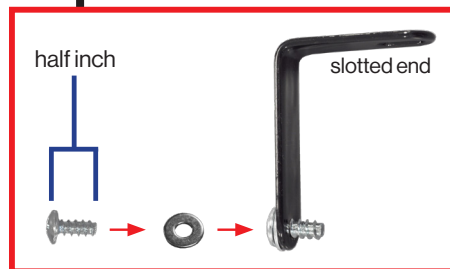
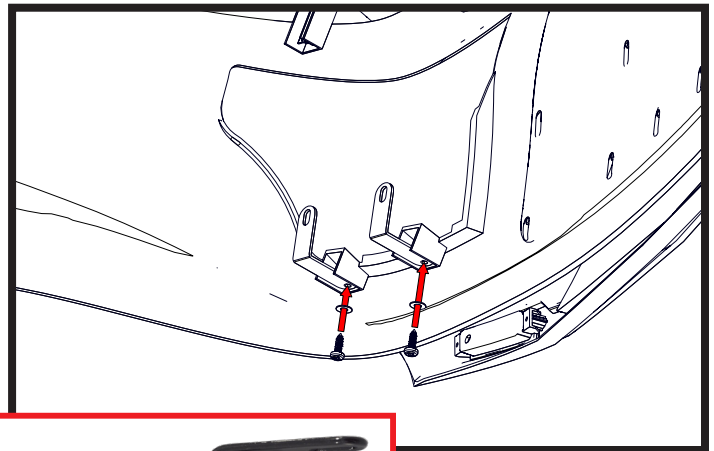

STEP 18

Attach the smallest 1.5" bracket to top inside mounting tab.

Attach 2.25" bracket to remaining mounting tab. Be sure that the slotted holes are facing towards the head light opening.

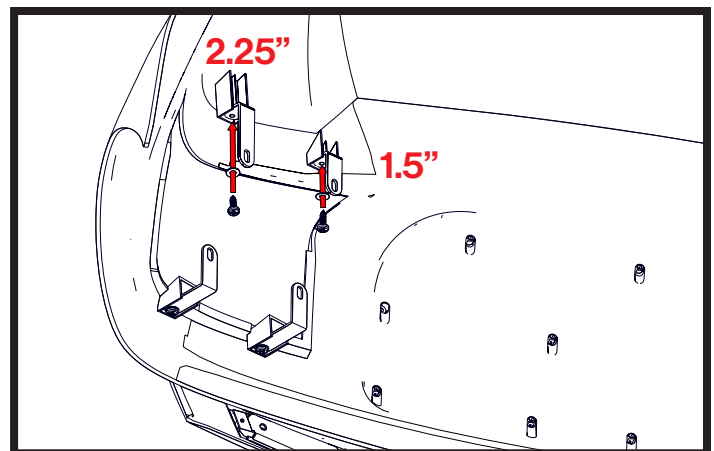

STEP 19

With cowl flipped over, be sure your light tab bracket locations are the same as the picture shown.

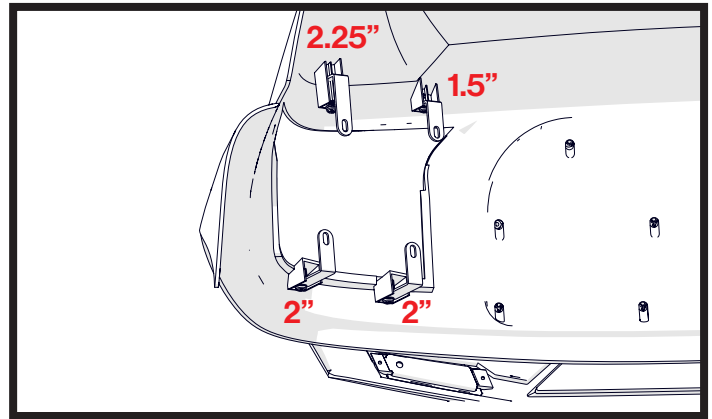

STEP 20

Place the supplied rubber seal around the headlight and insert light into cowl as shown.

Using the 1 inch screws and springs from hardware pack, attach the headlight to the mounting tabs as shown.

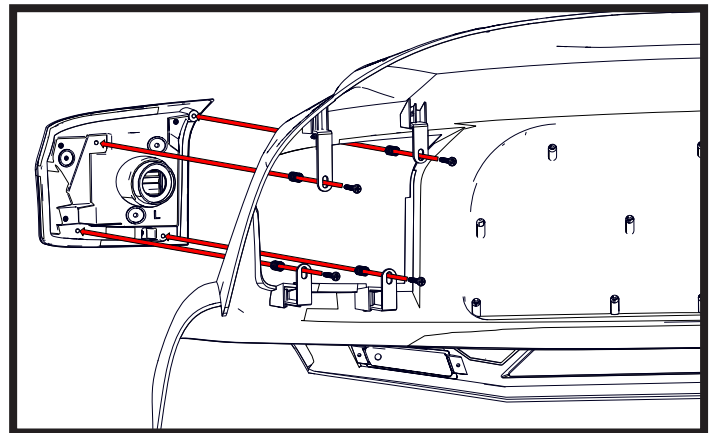

STEP 21

Be sure the screws and springs are attached as shown with the springs between the light housing and mounting brackets. If lights are not lining up flush, loosen screws and adjust accordingly.

Repeat process on the other side.

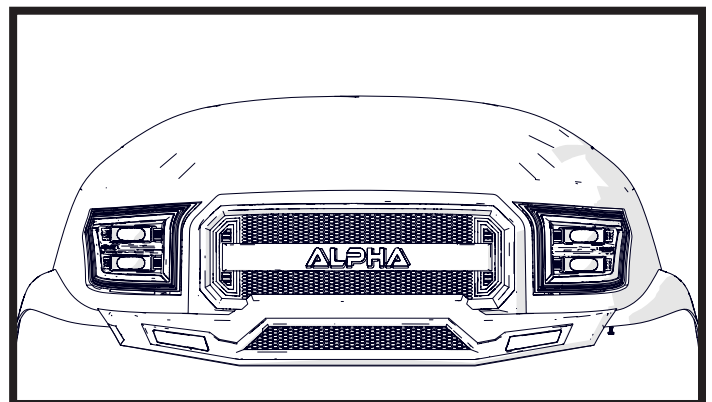

OPTIONAL **LUX** MODULE INSTALL FOR 02-107 ALPHA LUX LIGHT KIT

ATTENTION: For Ultimate Plus Light Kit Instructions (02-130), skip to Step 22.

To access the features of your LUX Module download the Happy Light App and follow the provided instructions.

STEP A

At the front of the car, connect the 2-Pin connector from LUX Module to the Main Harness.



STEP B

Plug 3 Pin Connector from LUX Module to 3-Pin on Headlights as shown.

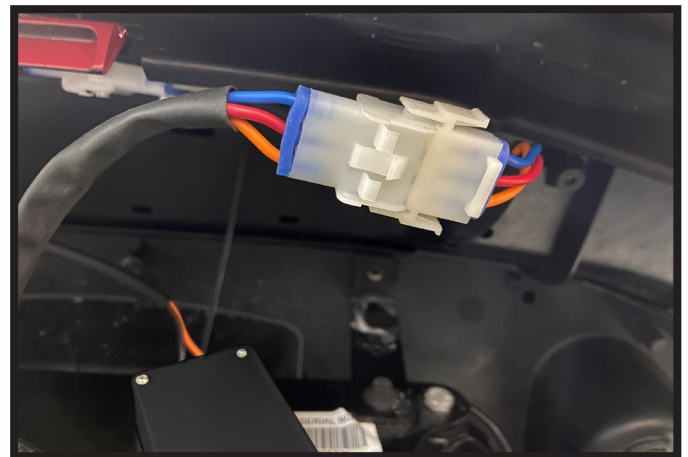

STEP C

Connect the 4-Pin Connector from Main Harness to 4-Pin Connector on Headlight.



OPTIONAL **LUX** MODULE INSTALL COMPLETE

STEP 22

Take passenger tail light (with red 4 pin connector) and attach the passenger side tail light bracket labeled (P) using the screws provided.



STEP 23

Plug tail light harness into bucket harness. Red connectors go to the passenger side.

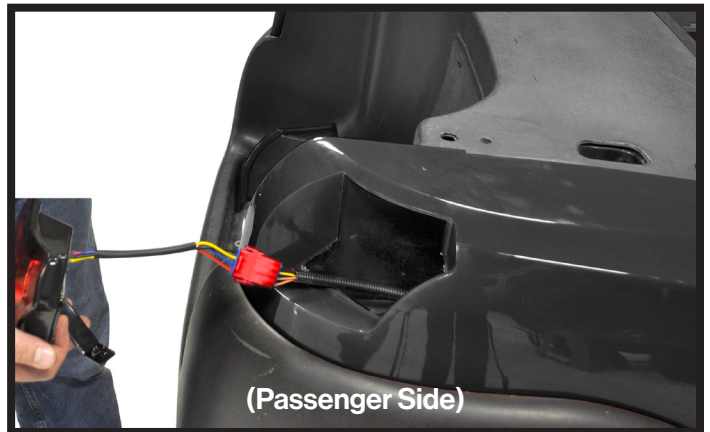

STEP 24

Locate the pre-drilled hole shown in your underbody.

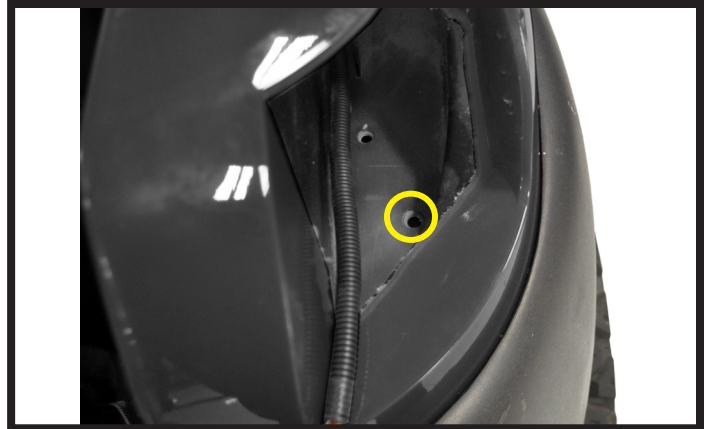

STEP 25

Using the 8mmx45mm hardware, attach light mounting bracket to underbody from tire well as shown. Once bolt is started, tighten. For any warranty purposes, this will be a way to quickly remove the tail lights.

Repeat process on other side. Reattach all factory seats, top, struts, etc.



STEP 26

CONVERTER AND POWER HOOKUP

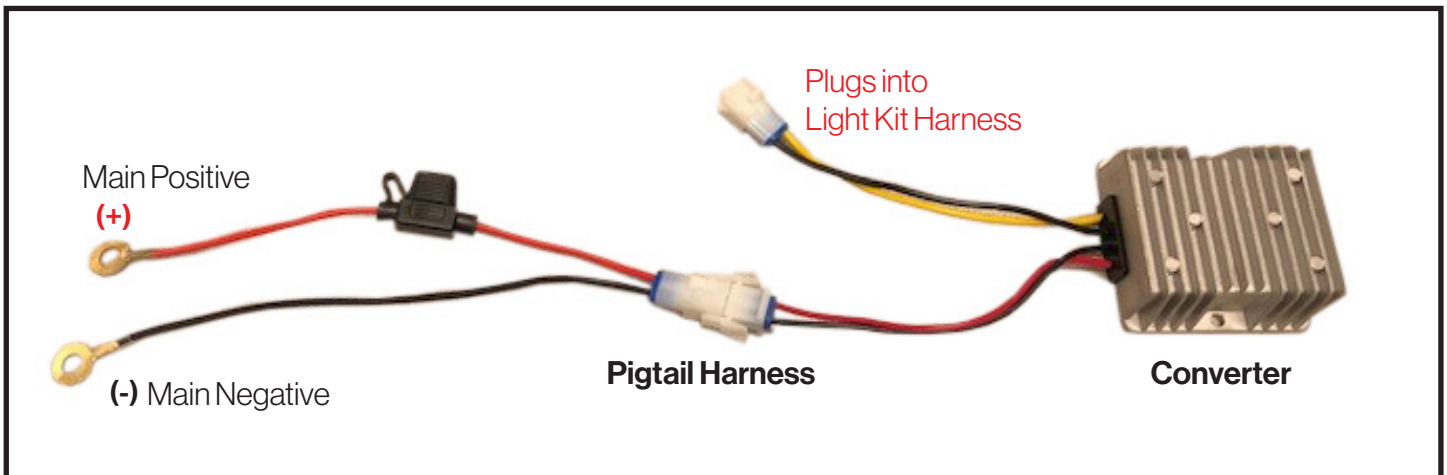

The voltage converter included must be used on all carts electric and gas. **Ensure the red & black pigtail harness with ring terminals above is disconnected from the converter and/or bucket harness.** Then connect the red wire with the fuse to the main positive terminal of the battery pack. Connect the black wire to the main negative terminal of the battery pack and tighten hardware.

Mount the converter to a flat surface under the seat within range of the pigtail harness. (Metal area is preferred). Plug the connector with the yellow and black wire from the converter into the light kit harness. Finally, connect the red and black connector from the converter to the pigtail harness (**you will notice a small arc in the connectors**). You can now place run/tow switch back to run.

***Use converter on gas carts to prevent Starter Generator voltage spikes that could cause damage to accessories.**

STEP 27

Now that power is connected check brake switch operation. Make adjustments if needed by repeating Step 15.

INSTALLATION COMPLETE

E-Z-GO®, TXT®, RXV® and S4® are registered trademarks of Textron Innovations, Inc. Club Car®, Precedent®, DS®, Onward® and Tempo® are registered trademarks of Ingersoll Rand, Inc. Yamaha®, Yamaha® Drive®, Drive2®, G-14®, G-16®, G-19®, G-22® and G-29® are registered trademarks of Yamaha Golf-Car Company. Any reference to Club Car®, E-Z-GO®, or Yamaha® or their associated trademarks, word marks, and products are only for purposes of identifying golf carts with which this MadJax product is compatible. MadJax products are aftermarket parts and are not original equipment parts. MadJax is not connected to, affiliated with, sponsored by, or endorsed by either Textron Innovations, Inc., Ingersoll Rand, Inc., Yamaha Golf Cart Company, or any of their parent or subsidiary companies.

WIRING LEGEND

ALPHA FRONT HARNESS

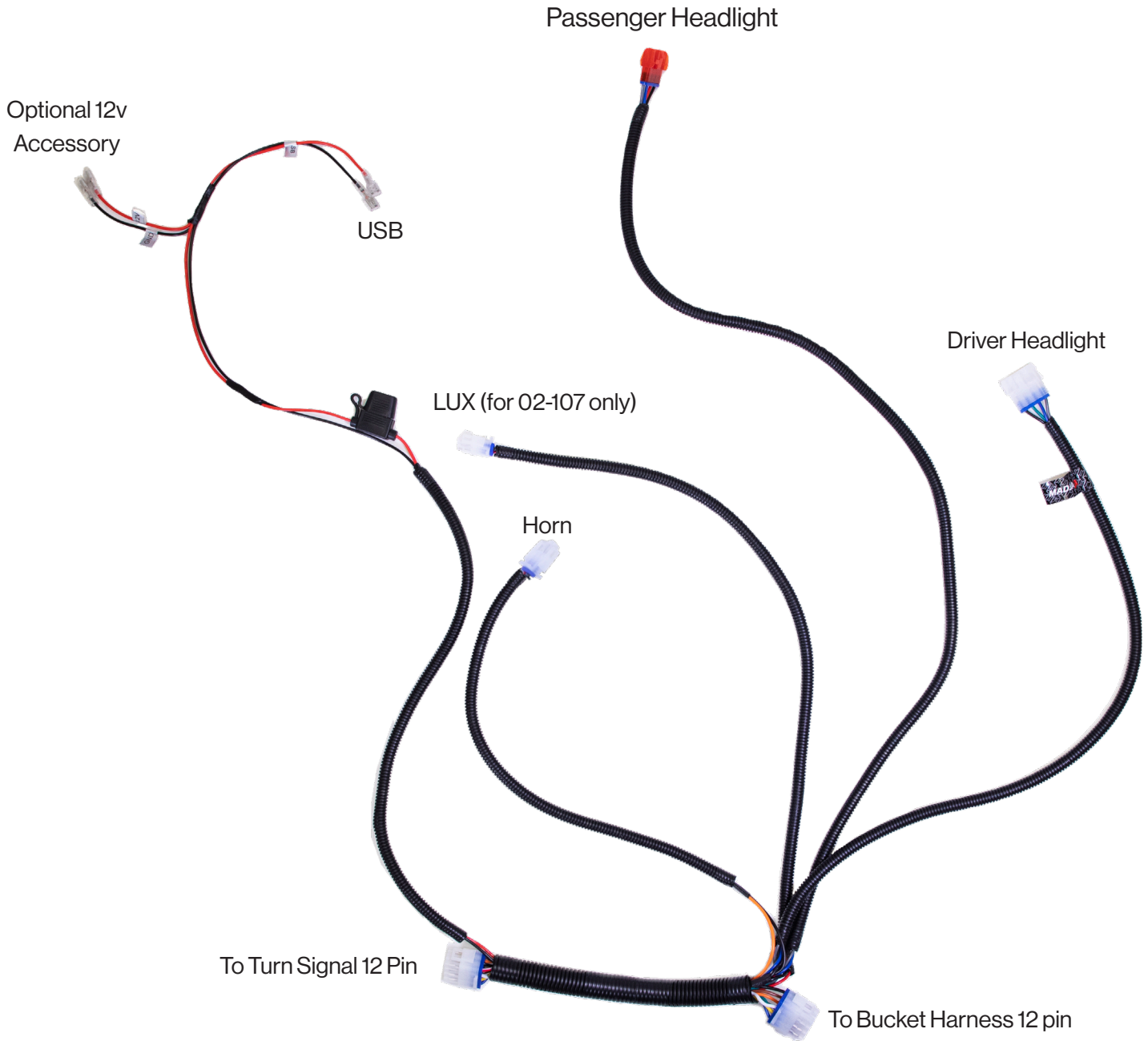

WIRING LEGEND

ALPHA BUCKET HARNESS

