

MADJAX

Part # 01-122/123 Genesis 250/300 Rear Seat

(will fit Yamaha® Drive2®)

ITEMS INCLUDED

- Hardware Packs 1-7
- 2 "Z" Brackets
- Grab Bar
- Bagwell Bracket
- Lean Back Brackets
- Armrests
- Footrest
- Main Frame

TOOLS NEEDED

- Drill
- 17mm Socket
- 17mm Wrench
- 14mm Socket
- 10mm Socket
- #3 Phillips Bit
- 3/8" Drill Bit
- 13mm wrench
- 15/64 Drill Bit

Only needed
for premium seats



Lean Back
Brackets
(Sold with 250/300
Cushions)



"Z" Brackets



Grab
Bar



Armrests



Bagwell Bracket



Footrest



Main Frame

WARNING:

Madjax recommends professional installation. If you choose to not have this product installed by a professional, we highly recommend that you exercise caution, care, and patience when installing this product as it involves drilling holes into your cart's body.

STEP 1

Remove hardware from struts and take off canopy.
Retain hardware.

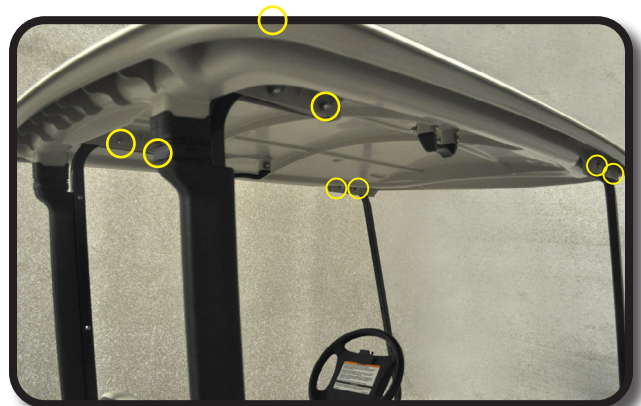

STEP 2

Remove hardware from gutters. Remove gutters by
sliding them upward. Retain hardware and gutters.

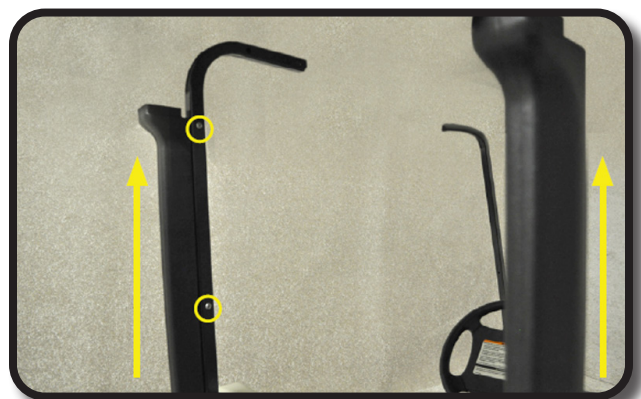

STEP 3

Remove rear struts from both sides of sweater basket. Retain hardware.



STEP 4

Remove seat back from sweater basket. Retain hardware.

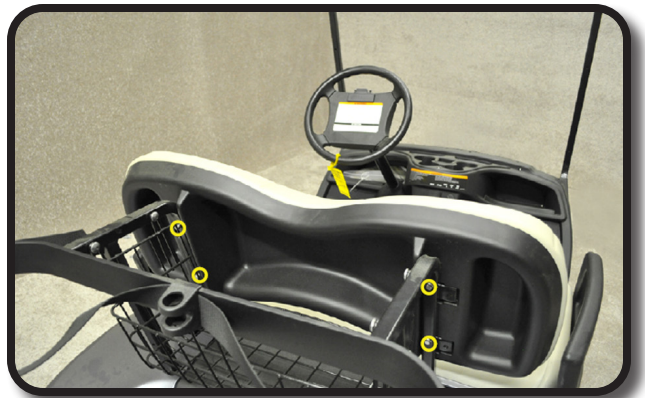

STEP 5

Remove sweater basket, retain hardware and rubber gromets.



STEP 6

Using retained hardware from Step 5, install new main brackets with strut tabs pointing outward.

Install rubber gromets and then tighten main brackets.



STEP 7

Install rear struts to front side of tabs on main support brackets, using retained hardware from Step 3.



STEP 8

Install front seat back to new support bracket using hardware retained from Step 4.



STEP 9

Install plastic gutters to factory struts using hardware retained from Step 2.



STEP 10

- A. Assemble bagwell support. Attach Z-bracket under angle support using hardware from Pack 4.
- B. Tighten hardware with nut on top side of angle support.



STEP 11

Place and center your assembled bagwell bracket for installation. Mark locations in bagwell. Using a 15/64 Drill bit, drill holes through bagwell and underlying frame.

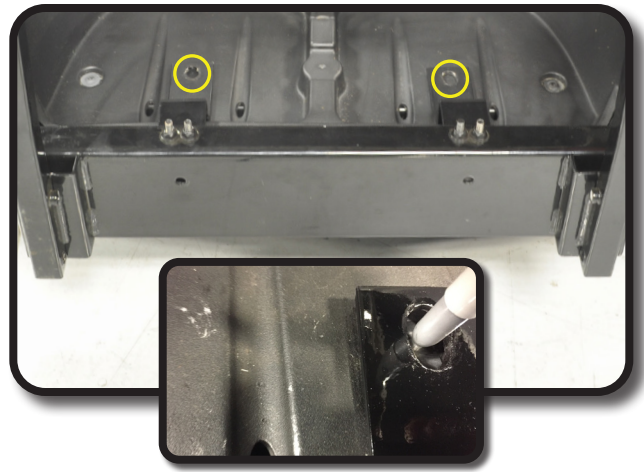

STEP 12

Mount assembled bracket with through bolts to bagwell and underlying frame using supplied hardware from Pack 1.

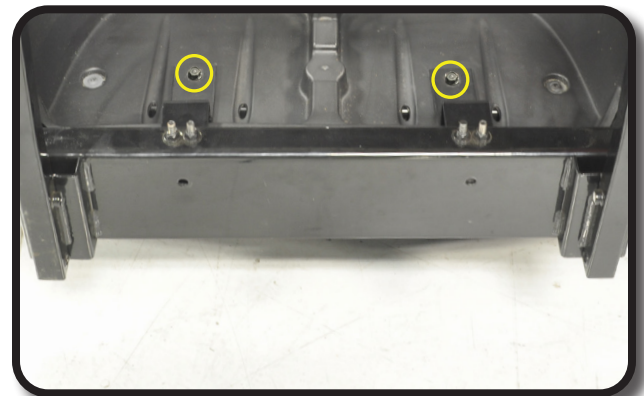

STEP 13

Attach main polyboard frame using 8 x 70mm hardware from Pack 2.

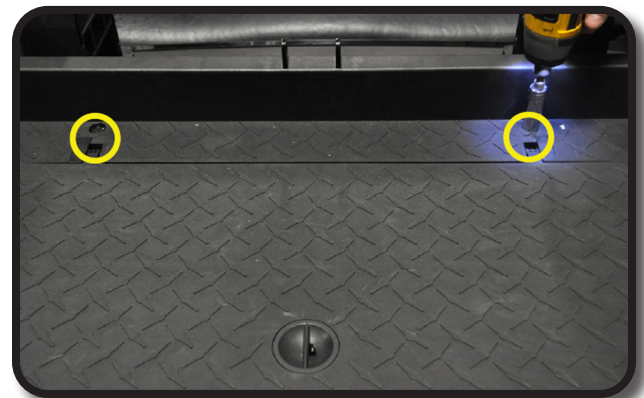

STEP 14

Attach main polyboard frame to bagwell brackets using 10 x 50mm hardware from Pack 2.

Do not tighten.



STEP 15

A) Using 3/8" drill bit with light pressure, slowly drill through back bumper as shown.

B) Using a #3 Phillips bit, attach bagwell bracket to cart using 10x100mm, countersunk hardware from Pack 2.



STEP 16

Attach bagwell bracket to cart using 10mm x 90mm hardware from Pack 1 and tighten.



STEP 17

If using 250/300 seat cushion attach lean back bracket that was packaged with the cushions to seat back frame using 8 x 70mm hardware from Pack 2.

Choose desired height and attach rear seat back cushion to bracket using hardware from Pack 5.

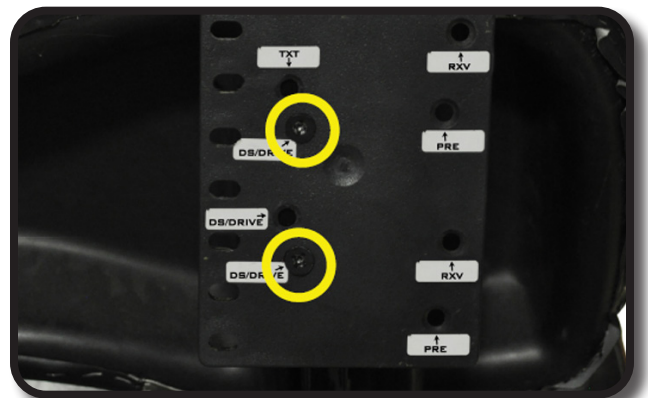

STEP 18

Attach footrest bracket as shown using hardware from Pack 6.

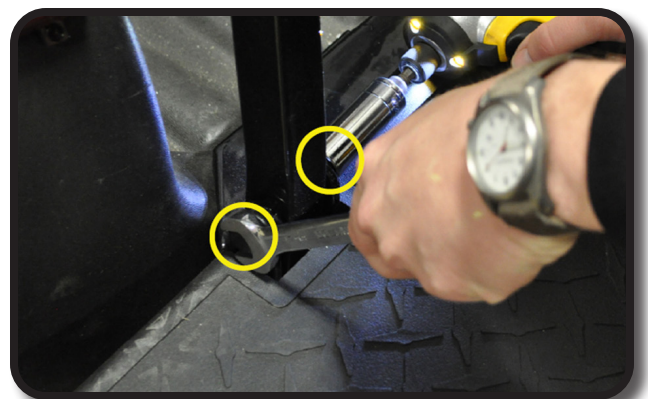

STEP 19

Attach grab bar to foot rest using additional hardware from Pack 6.

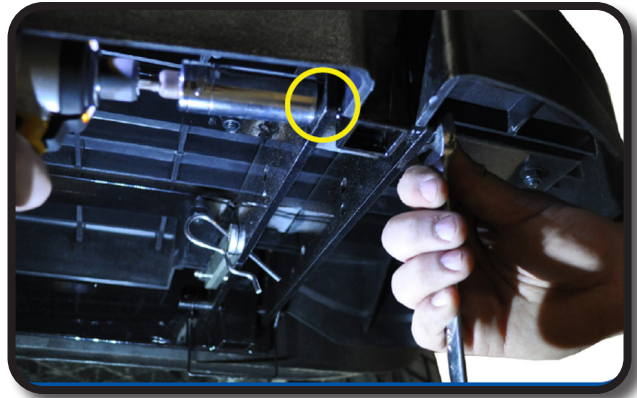

STEP 20

Using quick release pins from hardware pack 6, secure footrest to bagwell bracket.



STEP 21

Loosely attach seat bottom cushion using the Phillip's head hardware from Pack 7. Complete cushion installation by tightening it's hardware.



STEP 22

Footplate can be stowed by removing the four c-clips and folding upward. To lock footplate in up right poistion use brackets as shown.

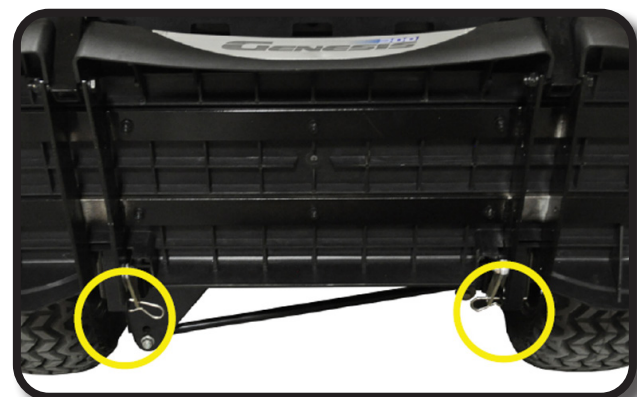

HARDWARE PACK

Pack 1

- 4 – 8x20mm countersunk #3 phillips
- 4 – 8x18mm flat washer
- 4 – 8mm lock nut
- 2 – 10x90mm hex bolt
- 4 – 10x20mm flat washer
- 2 – 10mm lock nut
- 4 – 6mm nut caps
- 4 – Rubber washers

Pack 2

- 2 – 8x70mm hex bolt
- 4 – 8x15mm flat washer
- 2 – 8mm lock nut
- 4 – 10x50mm Hex bolts
- 4 – 10x20mm flat washer
- 2 – 10mm lock nuts
- 10 – Rubber Washers
- 2 – 10x100mm countersunk #3 Phillips
- 2 – 10x20mm flat washer
- 2 – 10mm lock nuts

Pack 3

- 4 – 8x35mm hex bolt
- 4 – 8x15mm flat washer

Pack 4

- 4 – 8x30mm countersunk #3 Phillips
- 4 – 8x15mm flat washer
- 4 – 8mm locknut

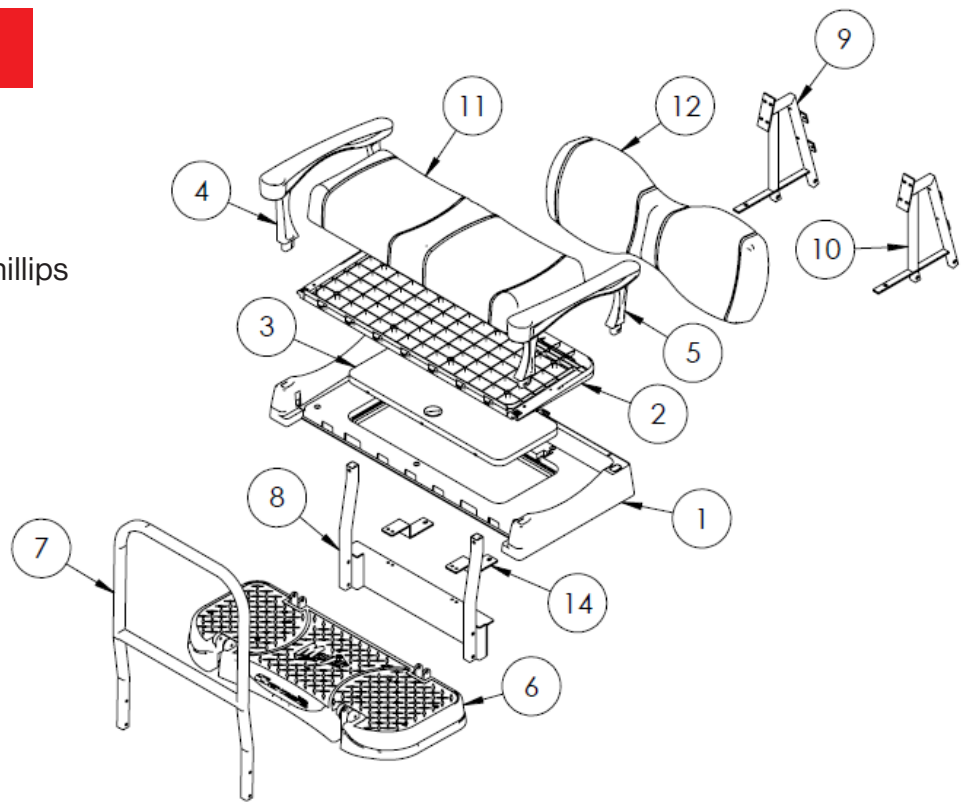

Pack 5

- 4 – 6x25mm hex bolt
- 4 – 6x15mm flat washer
- 4 – 6mm lock washer

Pack 6

- 4 – 10x75mm hex bolt
- 8 – 10x20mm flat washer
- 4 – 10mm Locknut
- 8 – Rubber washers
- 4 – Quick release pins (easy remove hardware for folding in the foot plate)

Pack 7

- 8 – 8x40mm countersunk